



Growatt 30000 TL3

Growatt 33000 TL3

Growatt 40000 TL3

Growatt New Energy Technology CO.,LTD

1st East & 3rd Floor, Jiayu Industrial Zone, Xibianling, Shangwu Village,
Shiyan, Baoan District, Shenzhen,P.R.China

T + 86 755 2747 1900

F + 86 755 2749 1460

E info@ginverter.com

W www.ginverter.com

Installation & Operation Manual

Contents

Copyright © 2010 SHENZHEN GROWATT NEW ENERGY TECHNOLOGY CO., LTD, All rights reserved.

No part of this document may be reproduced, stored in a retrieval system, or transmitted, in any form or by any means, electronic, mechanical, photographic, magnetic or otherwise, without the prior written permission of Shenzhen Growatt New Energy Technology Co., Ltd.

Shenzhen Growatt New Energy Technology Co., Ltd makes no representations, express or implied, with respect to this documentation or any of the equipment and/or software it may describe; including (with no limitation) any implied warranties of utility, merchantability, or fitness for any particular purpose. All such warranties are expressly disclaimed. Neither Shenzhen Growatt New Energy Technology Co., Ltd nor its distributors or dealers shall be liable for any indirect, incidental, or consequential damages under any circumstances.

(The exclusion of implied warranties may not apply in all cases under some statutes, and thus the above exclusion may not apply.)

Specifications are subject to change without notice. Every attempt has been made to make this document complete, accurate and up-to-date. Readers are cautioned, however, that Growatt reserves the right to make changes without notice and shall not be responsible for any damages, including indirect, incidental or consequential damages, caused by reliance on the material presented, including, but not limited to, omissions, typographical errors, arithmetical errors or listing errors in the content material.

All trademarks are recognized even if these are not marked separately. Missing designations do not mean that a product or brand is not a registered trademark.

Shenzhen Growatt New Energy Technology CO.,LTD
1st East & 3rd Floor, Jiayu Industrial Zone, Xibianling,
Shangwu Village, Shiyao, Baoan District, Shenzhen,P.R.China

1 Information on this Manual

- 1.1 Documents use
- 1.2 Symbols Used
- 1.3 Glossary

2 Safety

- 2.1 Intended Use
- 2.2 Safety Precautions
- 2.3 Assembly Warnings
- 2.4 Electrical Connection Warnings
- 2.5 Operation Warnings
- 2.6 Symbols on the inverter

3 Product Description

- 3.1 Inverter overview
- 3.2 Size and weight
- 3.3 Transportation
- 3.4 Storage of Inverter
- 3.5 The advantage of the inverter

4 Unpacking

5 Installation

- 5.1 Safety instruction
- 5.2 Selecting the Installation Location
- 5.3 Installation guide
- 5.4 Electrical Connections
- 5.5 Grid Type

6 Commissioning

- 6.1 Commission the Inverter
- 6.2 Operation Modes
- 6.3 Country Setting and LCD Display
- 6.4 M3 LCD Display
- 6.5 Double MPPT of the Growatt TL3
- 6.6 Communication

7 Start-up and Shut down the inverter

- 7.1 Start-Up the inverter
- 7.2 Shut down the Inverter

8 Maintenance and Cleaning

9 Trouble shooting

- 9.1 Error Messages displayed on LCD

10 Decommissioning

- 10.1 Dismantling the Inverter
- 10.2 Packing the Inverter
- 10.3 Disposing of the Inverter

11 Specification

- 11.1 Specification of Growatt TL3
- 11.2 DC connector info
- 11.3 Torque Values
- 11.4 Spare Parts and Accessories

12 Certificates

13 Contact

1 Information on this Manual

1.1 Documents use

1.1.1 Validity

This installation guide contains installation, commissioning, communication, trouble shooting. Information of Growatt TL3 series inverters:

- >Growatt 30000 TL3
- >Growatt 33000 TL3
- >Growatt 40000 TL3

With this installation guide, users are able to install and operate the inverters easily. This manual does not cover any details concerning equipment connected to the Growatt TL3. Store this manual where accessible at all times.

1.1.2 Target Group

This manual is for qualified persons who will operate, maintenance, service and repaired inverters.

1.1.3 Storage of the manual





Store this manual where it will be accessible at all times. We assume no liability for any damage caused by failure to observe these instructions. For possible changes in this manual, SHENZHEN GROWATT NEW ENERGY TECHNOLOGY CO.,LTD accepts no responsibilities to inform the users.

1.1.4 Additional Information

For further information on special topics in the download area at www.ginverter.com

1.2 Symbols Used

The following types of safety instructions and general information appear in this document as described below:

Symbol	Description
 DANGER	DANGER indicates a hazardous situation which, if not avoided, will result in death or serious injury.
 WARNING	WARNING indicates a hazardous situation which, if not avoided, could result in death or serious injury.
 CAUTION	CAUTION indicates a hazardous situation which, if not avoided, could result in minor or moderate injury.
 NOTICE	NOTICE indicates a situation which, if not avoided, could result in property damage.
 Information	Information that you must read and know to ensure optimal operation of the system.

1.3 Glossary

AC

Abbreviation for "Alternating Current"

DC

Abbreviation for "Direct Current"

Energy

Energy is measured in Wh (watt hours), kWh (kilowatt hours) or MWh (megawatt hours).

Power

Power is measured in W (watts), kW (kilowatts) or MW (megawatts). Power is an instantaneous value. It displays the power your inverter is currently feeding into the power distribution grid.

Power rate

Power rate is the ratio of current power feeding into the power distribution grid and the maximum power of the inverter that can feed into the power distribution grid.

Power Factor

Power factor is the ratio of true power or watts to apparent power.

PV

Abbreviation for photovoltaic

Wireless communication accessories (optional)

The external wireless communication technology is a radio technology that allows the inverter and other communication products to communicate with each other.

2.1 Intended Use

Growatt TL3 series inverters are to be used solely to feed solar energy converted photovoltaically into the public grid. Growatt TL3 series inverters are multi-string inverters with multi-MPP trackers, which mean they are able to connect to different PV module arrays.

Grid-tied PV system Overview:

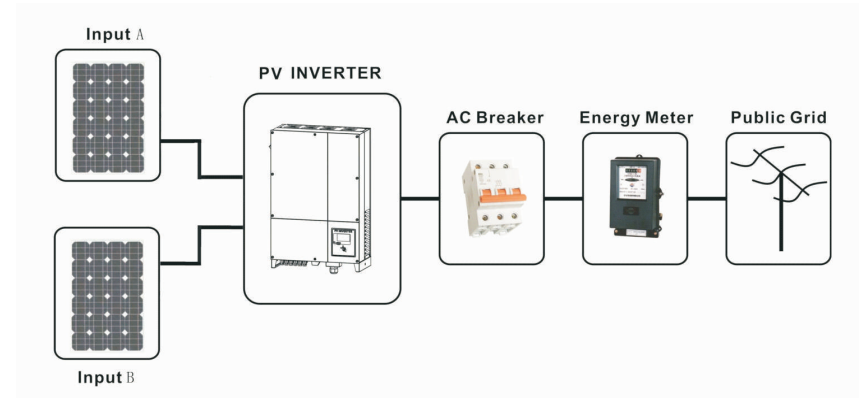

Fig 1.1

The inverter may only be operated with a permanent connection to the public power grid. The inverter is not intended for mobile use. Any other or additional use is not considered as intended use. The manufacturer is not responsible for any damages resulting from unintended use. Damage caused by such unintended use is at the sole risk of the operator.

As drawings shown above, a complete Grid-tied PV system consists of PV modules, PV inverters, public grid and other components. Moreover, PV inverters always act as key components.

When design a PV system contains Growatt TL3 series inverters or any other Growatt inverters, the system designing software ShineDesign (download from site: www.ginverter.com) will provide adequate supports.

PV modules Capacitive Discharge Currents

PV modules with large capacities relative to earth, such as thin-film PV modules with cells on a metallic substrate, may only be used if their coupling capacity does not exceed 470nF. During feed-in operation, a leakage current flows from the cells to earth, the size of which depends on the manner in which the PV modules are installed (e.g. foil on metal roof) and on the weather (rain, snow). This "normal" leakage current may not exceed 50mA due to the fact that the inverter would otherwise automatically disconnect from the electricity grid as a protective measure.





Information

If PV modules of the PV system require POSITIVE or NEGATIVE to connect to GROUND, or the capacitance relative to ground of the modules is large, please contact Growatt New Energy for technical support before installation.

2.2 Safety Precautions



The GROWATT TL3 series Inverters is designed and tested according to international safety requirements; however, certain safety precautions must be observed when installing and operating this inverter. Read and follow all instructions, cautions and warnings in this installation manual. If questions arise, please contact Growatt's technical services at +86 755 2747 1900.

2.3 Assembly Warnings



 <p>WARNING</p>	<ul style="list-style-type: none"> > Prior to installation, inspect the unit to ensure absence of any transport or handling damage, which could affect insulation integrity or safety clearances; failure to do so could result in safety hazards. > Unauthorized removal of necessary protections, improper use, incorrect installation and operation may lead to serious safety, shock hazards or equipment damage. > In order to minimize the potential of a shock hazard due to hazardous voltages, cover the entire solar array with dark material prior to connecting the array to any equipment.
 <p>CAUTION</p>	<ul style="list-style-type: none"> > Grounding the PV modules: Comply with the local requirements for grounding the PV modules and the PV generator. > Growatt recommends connecting the generator frame and other electrically conductive surfaces in a manner which ensures continuous conduction and ground these in order to have optimal protection of the system and personnel.

2.4 Electrical Connection Warnings











 <p>DANGER</p>	<ul style="list-style-type: none"> > Some components in the inverter are live. Touching live components can result in serious injury or death. > Danger to life due to high voltages in the inverter <ul style="list-style-type: none"> • All work on the inverter may be carried out by qualified personnel only. • The appliance is not to be used by children or persons with reduced physical, sensory or mental capabilities, or lack of experience and knowledge, unless they have been given supervision or instruction. > Children are forbidden to play around the Growatt inverter.
--	--

 WARNING	<p>> Make all electrical connections (e.g. conductor termination, fuses, PE connection, etc.) in accordance with prevailing regulations. When working with the inverter powered on, adhere to all prevailing safety regulations to minimize risk of accidents.</p> <p>> The Growatt TL3 series inverters may only be operated with PV generators (modules and cabling) with protective insulation. Do not connect any source of energy other than PV modules to the Growatt TL3 series.</p> <p>> Systems with inverters typically require additional control (e.g., switches, disconnects) or protective devices (e.g., fusing circuit breakers) depending upon the prevailing safety rules.</p> <p>> Please read this manual carefully, the manufacturer or supplier is not responsible for damage caused by incorrect operation, installation, wiring, transport, etc.</p>
 CAUTION	<p>> The Growatt inverter is to be used solely to feed solar energy converted photovoltaically into the public grid. The inverter is suitable for mounting indoors and outdoors.</p> <p>> You can use the AC current generated as follows:</p> <p>House grid: Energy flows into the house grid. The consumers connected, for example, household devices or lighting, consume the energy. The energy left over is fed into the public grid. When the Growatt TL3 series inverters do not generate any energy, e.g., at night, the consumers which are connected are supplied by the public grid. The energy displayed on the LCD of inverter is for reference only. When energy is fed into the public grid, the energy meter spins backwards.</p> <p>Public grid: Energy is fed directly into the public grid. The Growatt TL3 series inverters need install a separate energy meter. The energy produced is compensated at a rate depending on the electric power company.</p>

2.5 Operation Warnings

 WARNING	<p>> Ensure all covers and doors are closed and secure during operation</p> <p>> Although designed to meet all safety requirements, some parts and surfaces of Inverter are still hot during operation. To reduce the risk of injury, do not touch the heat sink at the back of the PV-Inverter or nearby surfaces while Inverter is operating.</p> <p>> Incorrect sizing of the PV plant may result in voltages being present which could destroy the inverter. The inverter display will read the error message " PV Voltage High "</p> <ul style="list-style-type: none"> • Turn the rotary switch of the DC Disconnect to the Off position immediately. • Contact installer.
 CAUTION	<p>> All operations regarding transport, installation and start-up, including maintenance must be operated by qualified, trained personnel and in compliance with all prevailing codes and regulations.</p> <p>> Anytime the inverter has been disconnected from the power network, use extreme caution as some components can retain charge sufficient to create a shock hazard; to minimize occurrence of such conditions, comply with all corresponding safety symbols and markings present on the unit and in this manual.</p> <p>> In special cases, there may still be interference for the specified application area despite maintaining standardized emission limit values (e.g. when sensitive equipment is located at the setup location or when the setup location is near radio or television receivers). In this case, the operator is obliged to take proper action to rectify the situation.</p> <p>> Possible damage to health as a result of the effects of radiation!</p> <ul style="list-style-type: none"> • Do not stay closer than 20 cm to the inverter for any length of time.

2.6 Symbols on the inverter

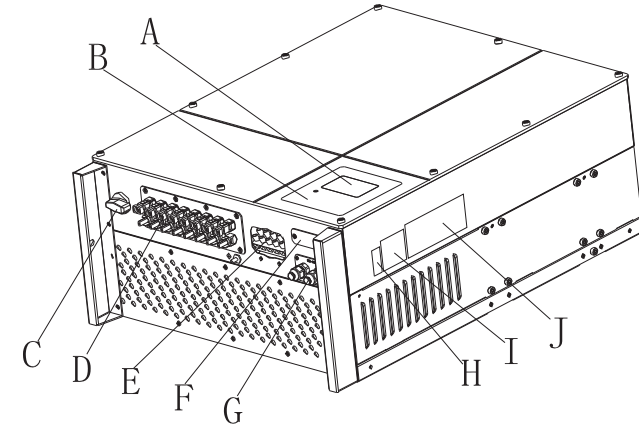

Symbol	Explanation
	Electrical voltage!
	Risk of burns!
	Point of connection for grounding protection.
	Operation after 5 minutes
	Direct Current (DC)
	Alternating Current (AC)
	CE mark. The inverter complies with the requirements of the applicable EC guidelines.
 	EU waste electrical and electronic equipment (WEEE) label
	Read the manual

3.1 Inverter overview



Position	Description
A	LCD
B	LED
C	DC Switch
D	PV input terminals
E	AC output
F	RS232 lid
G	RS485
H	Series Number
I	Warning Label
J	Type label

Symbol on the inverter

Symbol	Description	Explanation	
	Tap symbol	Indicates display operation (see Section 6).	
	Inverter state symbol	Green/constant	Operation
		Red/constant	1.Fault– contact installer 2.Standby mode
		Red/flashing	1.Warning– contact installer 2.Software update

3.2 Size and weight

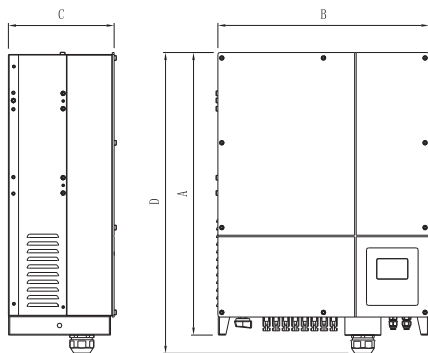

	A(mm)	B(mm)	C(mm)	D(mm)	Weight(kg)
30000-40000 TL3	740	550	276	778	61.6

3.3 Transportation

The inverter is thoroughly tested and inspected strictly before delivery. Our inverters leave our factory in proper electrical and mechanical condition. Special packaging ensures safe and careful transportation. However, transport damage may still occur. The shipping company is responsible in such cases. Thoroughly inspect the inverter upon delivery. Immediately notify the responsible shipping company if you discover any damage to the packaging which indicates that the inverter may have been damaged or if you discover any visible damage to the inverter. We will be glad to assist you, if required. When transporting the inverter, the original or equivalent packaging should to be used, and the maximum layers for original carton is four, as this ensures safe transport.

3.4 Storage of Inverter

If you want to storage the inverter in your warehouse, you should choose an appropriate location to store the inverter.

- > The unit must be stored in original package and desiccant must be left in the package.
- > The storage temperature should be always between -25°C and +60°C. And the storage relative humidity should be always between 0 and 95%.
- > If there are lots of inverters need to be stored, the maximum layers for original carton is four.
- > After long term storage, local installer or service department of GROWATT should perform a comprehensive test before installation

Information

After long term storage, the Real Time Clock of the inverter maybe not correct, it will cause the Energy produced today (E_day) error, you need to set the time and date, refer to refer to 6.3.4 setting inverter time or 6.4.3 text line d) setting date and time.

3.5 The advantage of the inverter

The features of the inverter are below:

- Dual independent MPP trackers
- Integrated DC disconnect switch
- RS232/RS485/RF/Ethernet/Wi-Fi
- Wide PV voltage range: 180V~1000V
- The maximum efficiency is 98.2%
- IP65 environmental protection
- Remote update capability
- Easy to install

Before opening the packing box of Growatt TL3, please note that whether there are any visible external damages.

Once open the packing box, please check the delivery for completeness and for any visible external damages of the inverter. If there are anything damaged or missing, please contact your dealer. Complete delivery should contain as follows.

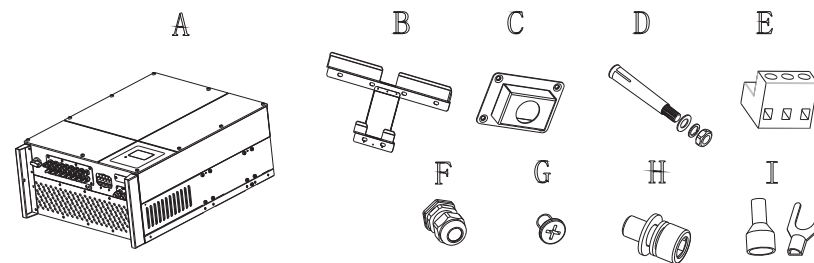

Fig 4.1

Item	Quantity	Description
A	1	Growatt TL3 inverter
B	1	Mounting frame
C	1	Waterproof cover
D	6	Explosion screw
E	2	RS485 connector
F	1	Cable gland for AC connection
G	4	M4 cross recessed countersunk head screws
H	2	M6 socket head cap screws
I*	4/5	Cord end terminal or Y terminal
--	1	Warranty(not show in the picture)
-	1	User manual (not show in the picture)

* Number of I is 4 for Growatt 40000 TL3, and 5 for Growatt 30000/33000 TL3.





Information

Though the packaging box of the inverter is durable, please treat the packing box gently and avoid dispose the packing box.

5 Installation

5.1 Safety instruction

	<p>Danger to life due to fire or explosion</p> <ul style="list-style-type: none"> > Despite careful construction, electrical devices can cause fires. > Do not install the inverter on easily flammable materials and where flammable materials are stored.
	<p>Risk of burns due to hot enclosure parts</p> <p>Mount the inverter in such a way that it cannot be touched inadvertently.</p>
	<p>Possible damage to health as a result of the effects of radiation!</p> <p>In special cases, there may still be interference for the specified application area despite maintaining standardized emission limit values (e.g. when sensitive equipment is located at the setup location or when the setup location is near radio or television receivers). In this case, the operator is obliged to take proper action to rectify the situation.</p> <p>Never install the inverter near the sensitive equipment (e.g. Radios, telephone, television, etc)</p> <p>Do not stay closer than 20 cm to the inverter for any length of time unless it is absolutely necessary.</p> <p>Growatt assumes no responsibility for compliance to EMC regulations for the complete system</p>

- > All electrical installations shall be done in accordance with the local and national electrical codes. Do not remove the casing. Inverter contains no user serviceable parts. Refer servicing to qualified service personnel. All wiring and electrical installation should be conducted by a qualified service personnel.
- > Carefully remove the unit from its packaging and inspect for external damage. If you find any imperfections, please contact your local dealer.
- > Be sure that the inverters connect to the ground in order to protect property and personal safety.
- > The inverter must only be operated with PV generator. Do not connect any other source to it.
- > Both AC and DC voltage sources are terminated inside the PV Inverter. Please disconnect these circuits before servicing.
- > This unit is designed to feed power to the public power grid (utility) only. Do not connect this unit to an AC source or generator. Connecting Inverter to external devices could result in serious damage to your equipment.
- > When a photovoltaic panel is exposed to light, it generates a DC voltage. When connected to this equipment, a photovoltaic panel will charge the DC link capacitors.
- > Energy stored in this equipment's DC link capacitors presents a risk of electric shock. Even after the unit is disconnected from the grid and photovoltaic panels, high voltages may still exist inside the PV-Inverter. Do not remove the casing until at least 5 minutes after disconnecting all power sources.
- > Although designed to meet all safety requirements, some parts and surfaces of Inverter are still hot during operation. To reduce the risk of injury, do not touch the heat sink at the back of the PV-Inverter or nearby surfaces while Inverter is

5.2 Selecting the Installation Location

This is guidance for installer to choose a suitable installation location, to avoid potential damages to device and operators.

- 1) The wall selected to install the inverter must be strong and firm enough to support and bear the weight of the inverter for a long period time. (Refer to Chapter 3.2)
- 2) The location selected must be suitable for inverters' dimension. (Refer to 3.3 Dimensions and Fig.5.2 Required Clearances)
- 3) Do not install the inverter on structures constructed of flammable or thermo labile materials.
- 4) Never install the inverter in environment of little or no air flow, nor dust environment.
- 5) The Ingress Protection rate is IP65 which means the inverter can be installed outdoors and indoors.
- 6) Do not subject the inverter to any direct sunlight.
- 7) The ambient temperature of the inverter should be $-25^{\circ}\text{C}\sim+60^{\circ}\text{C}$.
- 8) The installation location must be freely and safely to get at all times.
- 9) Vertically installation and make sure the connection of inverter must be downwards. Never install horizontal and avoids forward and sideways tilt.(Refer to drawings below)

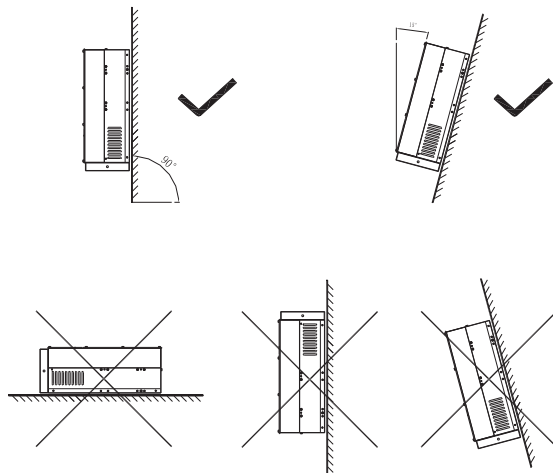

- 10) Notice the minimum clearances of the inverter. (Refer to Chapter3.2 and Fig.5.2 Required Clearances).

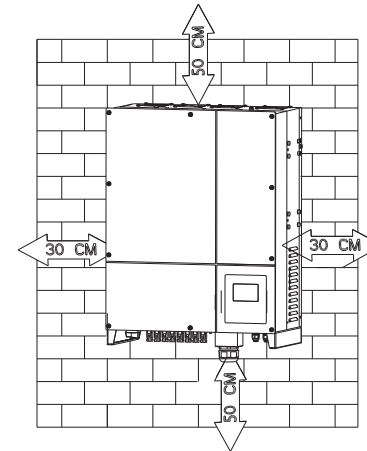

Fig 5.2

- 11) Do not install the inverter near television antenna or any other antennas and antenna cables.
- 12) Do not install the inverter in living area, the noise caused by the machine may affect on daily life.
- 13) For security reasons, don't install the inverter in place where the children can reach.

5.3 Installation guide

5.3.1 Mounting the Bracket



DANGER

In order to avoid electrical shock or other injury, inspect existing electronic or plumbing installations before drilling holes.

To mount the inverter on the wall, we should mount the bracket to the wall firmly first of all.

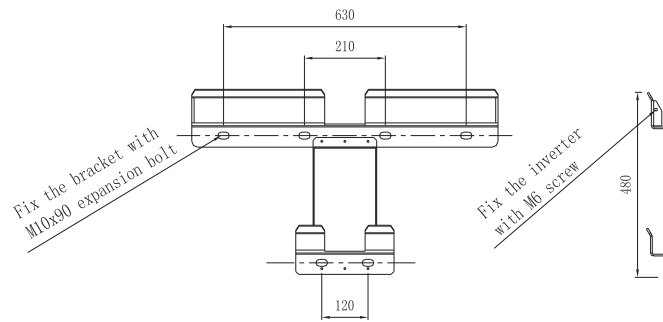

Bracket of Growatt TL3
Fig 5.3

Hint: Data units in mm

Steps:

- Drill holes for screws while use the mounting frame as template.
- Fix the mounting frame on the wall as the figures shown below, combine as the screws as the Items Fig 4.1 shows (items D)

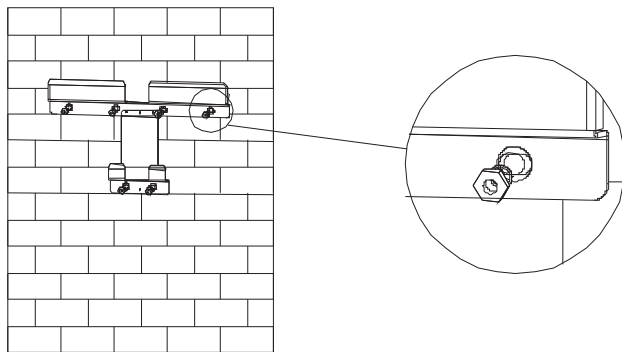

Fig 5.4

5.3.2 Mounting Inverter



WARNING

Falling equipment can cause serious or even fatal injury, never mount the inverter on the bracket unless you are sure that the mounting frame is really firmly mounted on the wall after carefully checking.

After the bracket is firmly mounted on the wall, then mount the inverter on the bracket.

- Rise up the Growatt TL3 a little higher than the bracket. Considering the weight of Growatt TL3, you need to hang on the inverter. During the process please maintain the balance of the Growatt TL3. Please reference in Fig 5.5(a).
- Hang the inverter on the bracket through the match hooks on bracket and the back of the inverter.
- Installed one M6*10 screw at each side of inverter to reliable fixed it on the wall. Please reference in Fig 5.5(b).
- Connection of a second protective conductor. Please reference in Fig5.6.
- Recommend awning installation, the purpose is to extend the inverter service life and reduce the power derating of the inverter. The dimension of the awning refer to Fig5.8.

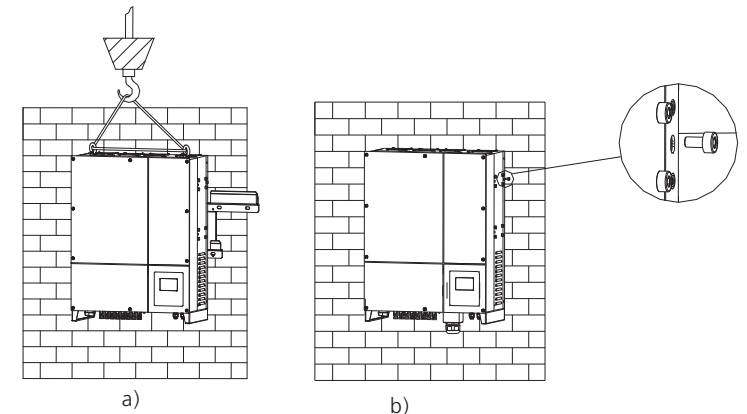

Fig 5.5

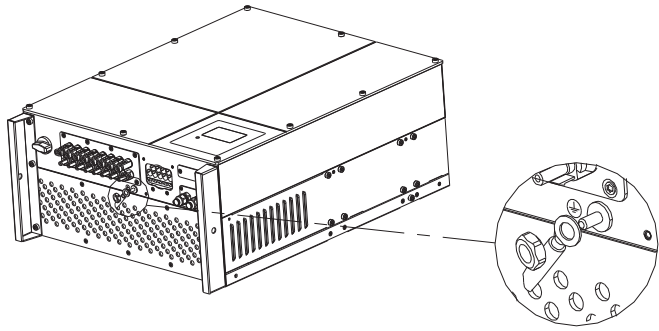

Fig 5.6

5.3.3 Installation layout



Information

Avoid exposing inverter to direct sunlight, rain or snow to extend the inverter service life despite the IP65 protection degree. Exposure to the sunlight may cause additional internal heating which will cause power derating.

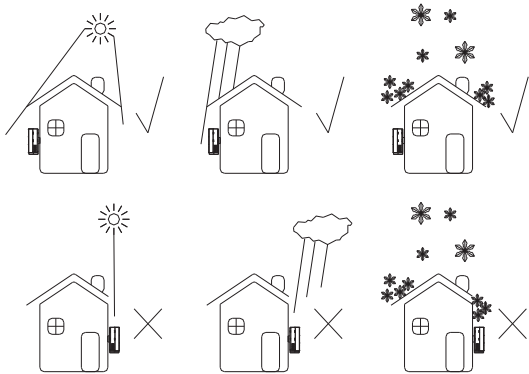

Fig 5.7

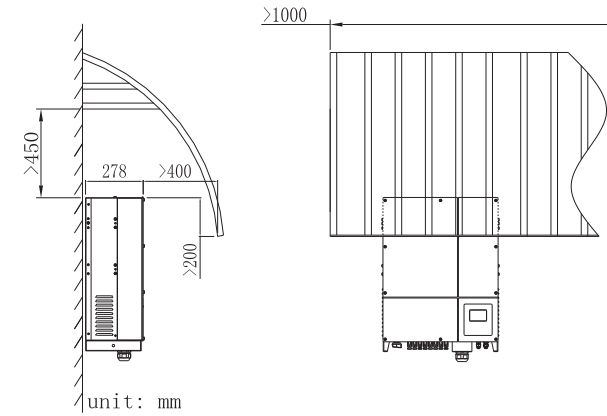

Fig 5.8

More than one inverter need to be installed, the dimensions below should be considered.

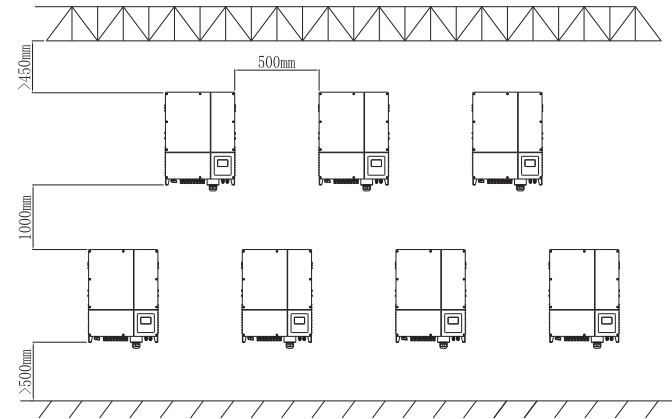



Fig 5.9

5.4 Electrical Connections

5.4.1 Safety

 <p>DANGER</p>	<p>Danger to life due to lethal voltages!</p> <p>High voltages which may cause electric shocks are present in the conductive parts of the inverter. Prior to performing any work on the inverter, disconnect the inverter on the AC and DC sides</p>
 <p>WARNING</p>	<p>Danger of damage to electronic components due to electrostatic discharge.</p> <p>Take appropriate ESD precautions when replacing and installing the inverter.</p>

5.4.2 Wiring AC Output

Conditions for the AC Connection

You must comply with the connection requirements of your utility operator.

All usages must comply with the regulations.

Residual-current protective device

The inverter is equipped with an integrated universal residual-current monitoring unit.

If the network operator stipulates a residual-current protective device, you must use a residual-current protective device that triggers in the event of a residual-current of 100 mA or more.

Connection of a second protective conductor

In some installation countries, a second protective conductor is required to prevent a touch current in the event of a malfunction in the original protective conductor.

For installation countries falling within the scope of validity of the IEC standard 62109, you must install the protective conductor on the AC terminal with a conductor cross-section of at least 10 mm²Cu.

Or install a second protective conductor on the earth terminal with the same cross-section as the original protective conductor on the AC terminal.

Load disconnection unit

You must install a separate three-phase miniature circuit-breaker or other load disconnection unit for each inverter in order to ensure that the inverter can be safely disconnected under load.

- Measure the public grid voltage and frequency (Voltage: 400Vac or 480Vac for 40000 TL3; Frequency: 50Hz/60Hz; in 3-Phase);
- Open the breaker between the PV inverter and utility;

Specification of AC breaker: Growatt 30000 TL3: 63A/400V
 Growatt 33000 TL3: 80A/400V
 Growatt 40000 TL3: 80A/480V

Cable requirements:

Model	Area(mm ²)	Available wire gauge (AWG)
Growatt 30000 TL3	10~16	7~5
Growatt 33000 TL3	10~16	7~5
Growatt 40000 TL3	10~16	7~5

Conductor Cross section	Max. cable length(m)		
	Growatt 30000 TL3	Growatt 33000 TL3	Growatt 40000 TL3
10.0 mm ²	30	25	25
14.0 mm ²	42	38	38
16.0 mm ²	50	45	45



NOTICE Please do not use single-core wire cable.

Connection to the AC side terminal

- 1.The AC side terminals of the inverter are like the following figure, it is clear to confirm that 'L1, L2, L3' represents three live line output, 'N' represents neutral line and  is grounding line.
- 2.Connect five standard cables into relevant terminals. The five cables should be put through the protection shell, as figure below.

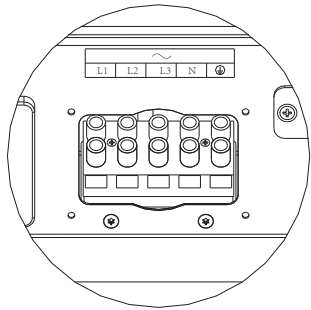

Fig 5.10

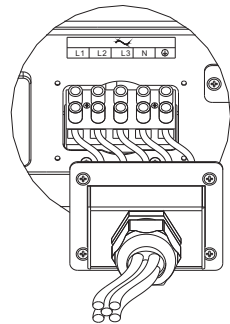

Fig5.11

- 3.Fasten the protection shell onto the bottom of the inverter, make sure the four screws are tightened, the completed appearance is like the below figure

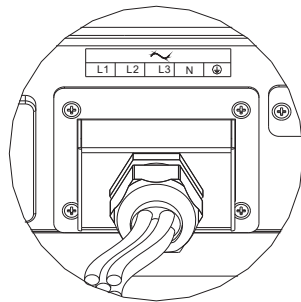

Fig 5.12

5.4.3 Wiring DC Input

Danger to life due to lethal voltages!



DANGER

Before connecting the PV array, ensure that the DC switch and AC breaker are disconnect from the inverter. NEVER connect or disconnect the DC connectors under load.



WARNING

Improper operation during the wiring process can cause fatal injury to operator or unrecoverable damage to the inverter. Only qualified personnel can perform the wiring work.



WARNING

Risk of damage to the inverter.

If the voltage of the PV modules exceeds the maximum input voltage of the inverter, it can be destroyed by the overvoltage. This will void all warranty claims.

Do not connect strings to the inverter that have an open-circuit voltage greater than the maximum input voltage of the inverter.



WARNING

To reduce the risk of electric shock, avoid touching the live components and treat the terminals carefully.



Information

The PV modules should have an IEC61730 Class A rating*.

Please use the same brand male and female PV connectors.

Under any conditions the total circuit current should never exceed the Max. Current.

*Relate only to transformerless installation.



NOTICE

Excessive voltages can destroy the measuring device

Only use measuring devices with a DC input voltage range up to at least 1,000 Vdc.

1. Check the connection cables of the PV modules for correct polarity and make sure that the maximum input voltage of the inverter is not exceeded.

2. The diagram drawing of DC side is shown as below, notice that the connectors are in paired (male and female connectors). The connectors for PV arrays and inverters are H4 (AMPHENOL) connectors;

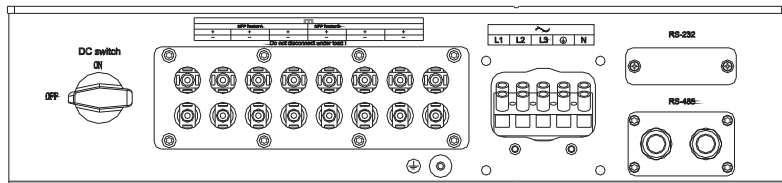

Fig 5.21

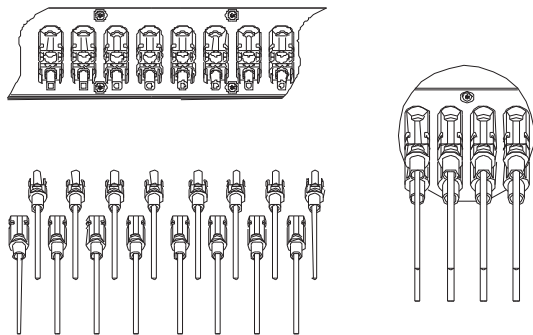

Fig 5.22

3. Check the assembled DC connectors for correct polarity and connect them to the inverter.

4. The maximum MPP tracker currents are varying from different inverter types.

Type	Max.current
30000 TL3	35A
33000 TL3	38A
40000 TL3	38A

5. In order to seal the inverter, all unneeded DC inputs must be closed with sealing plugs:

Cable requirements:

Model	Diameter(mm)	Area(mm ²)	AWG
30000 TL3	2.05	3.332	12
33000 TL3	2.05	3.332	12
40000 TL3	2.05	3.332	12

5.4.4 Grounding

AC Grounding

The Growatt TL3 must be connected to the AC grounding conductor of the power distribution grid via the ground terminal (PE).

PV Grounding

The grounding conductor in the framework of the PV array must be connected to the PV grounding conductor and the DC grounding conductor. The cross-section of the grounding conductor corresponds to the cross-section of the largest conductor in the DC system.

DC Grounding Conductor

A DC grounding conductor may be required by the Authority Having Jurisdiction (AHJ). Use the terminal block for the PV grounding conductor and DC grounding conductor.

Ground kit

If PV modules of the PV system require POSITIVE or NEGATIVE to connect to GROUND, the output of inverter should connect to grid with an isolating transformer. The connection method is below:

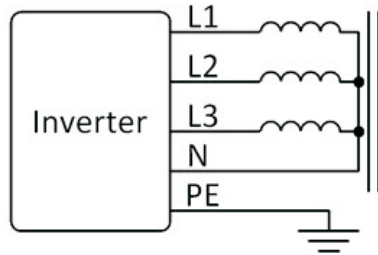

Neutral of transformer should not be connected to PE.

5.5 Grid Type

5.5.1 Common grid type



NOTICE

For TT grid mode, the valid value of the Neutral to PE voltage should be less than 30 V.

Based on the local GRID standards, it may select different connection types. In the following you will find an overview of the most common type of grid structure.

Power grid modes supported by the Growatt 30000-33000 TL3.

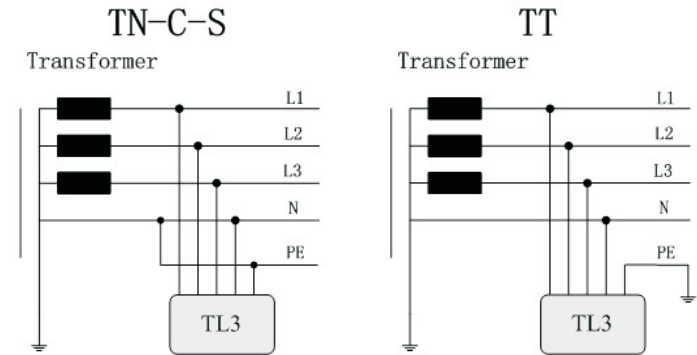
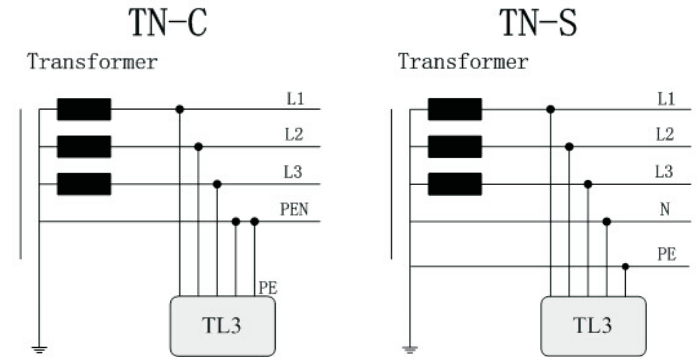

Power grid mode supported by the Growatt 40000 TL3.

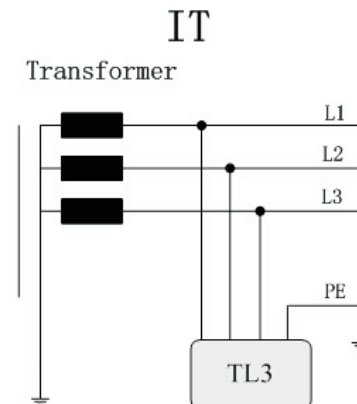

6 Commissioning

6.1 Commission the Inverter

- 1) Remove all covers from the PV array.
- 2) Check the PV and AC voltage.
- 3) Plug in the PV input.
- 4) Turn on the DC switch.
- 5) If the inverter is connected with PV panel arrays and the input voltage is higher than 250Vdc, while the AC grid is not connected yet, LCD will display messages in order as below:
 - Company info → Basic info → State info
 - The LCD will display “ AC V outrange “ at State info and the LED turns red.
 - Please check all information on the LCD, operate by knocks you will see the different parameters.
 - Single knock to Light the backlight → State info (single knock) Input info → (single knock) Output info
- 6) Turn on the AC breaker between inverter and grid, the system will operate automatically.
- 7) Under normal operating conditions, the LCD displays ‘Power: xx.xx Kw’ at State info, this is the power feed into grid. The LED turns green.
- 8) Check the time and date of inverter as follow:

Single knock to Light the backlight → State info (Thrice knock) → Inverter info (single knock) → System Time(double knock), if they are not correct, please set them, refer to refer to 6.3.4 setting inverter time or 6.4.3 text line d) setting date and time.
- 9) Finish commissioning.

6.2 Operation Modes

Normal Mode

In this mode, the inverter works normally and LED turns green.

- Whenever the DC voltage is higher than 300Vdc, inverter converts power to grid as generated by the PV panels;
 - Whenever the DC voltage is lower than 250Vdc, the inverter will work in waiting state and attempt to connect the grid. In waiting state the inverter consumes just enough power generated by the PV panel to monitor the internal system.
- Notes: The inverter starts up automatically when DC power from the PV panel is sufficient.

Fault Mode

The internal intelligent controller can continuously monitor and adjust the system state. If inverter finds any unexpected conditions such as system fault and inverter fault, the fault information will be displayed on the LCD. In fault mode the LED turns red.

Notes: a) Detailed fault information refers to Chapter 9.1 ERROR messages displayed on LCD.

b) When PV Isolation error occurred in SAA safety standard, the buzzer will give an alarm every fifteen seconds.

Shutdown Mode

Inverters automatically stop running during periods of little or no sunlight. In shutdown mode the inverters take no power from the grid and panel, and the LCD and LED turns off.

Notes: If the PV string DC voltage is too low, the inverter will also turn to Shutdown Mode.

Derating mode

When AC frequency is higher than 50.3Hz(settable), the inverter will derate its output power according to the rule. When user set the output limit command to the inverter, the inverter will also limit the output according to the setting.

In this derating mode, the LCD will show “DERATING”.

6.3 Country Setting and LCD Display

In the lower right corner of inverter there is the LCD display. We can check inverter running state, historical generation data, etc, on the LCD screen. Items displayed can be changed by knock; you can also change some inverter parameters by knock.

6.3.1 Country Setting

If it is the first time the inverter starts up after installation, LCD will quickly switch to and stay at the country setting interface. Only the inverter is set to comply with a certain country rule, it will work and display normally. Otherwise, LCD will always stay at the 'Please select' interface.

Please finish the country setting according to the following steps:

1) When at the first interface 'Select country:' the option is 'VDE0126' in default. By single knock, countries will vary from one to another, for example, 'France', as Fig 6.3.1



Fig 6.3.1



Fig 6.3.2

Note: If you have ordered the inverter with specific country settings, the parameters have been preset in factory and you don't need to operate this step any more.

2) There are eleven countries or rules to select:

1	VDE0126
2	Germany
3	France
4	Italy
5	Greece
6	Hungary
7	Belgium
8	Turkey
9	Denmark
10	Spain
11	UK-G59

Note: if you can't find the country you want, please contact Growatt.

3) When it comes to the country you want, double knock to enter, as Fig 6.3.3.

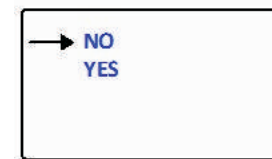

Fig 6.3.3

4) When enter the confirm interface, there are two options 'NO' and 'YES', and the cursor will stay at 'NO' in default, single knock to shift between 'NO' and 'YES', double knock to confirm your selection. When at 'NO', double knock will exit, when at 'YES', double knock will set up. After the setting is successful, the LCD will display "Set Country OK", and inverter will reboot automatically.

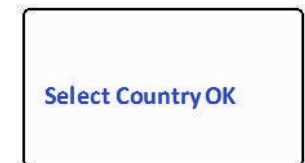
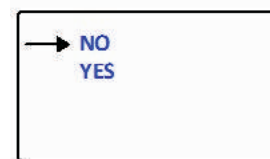

Fig 6.3.4

6.3.2 Power on Display

Power on display

After inverter restarts, LCD background will light automatically. Growatt Logo will appear immediately. The background light will last for 2 seconds. See Fig6.3.5 for reference.

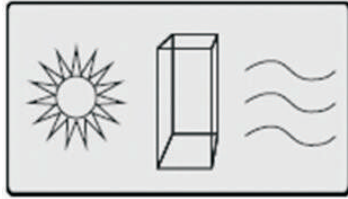

Fig6.3.5 Power on Growatt Logo

After displaying Growatt Logo for 2 seconds, LCD screen will switch to the second interface; display the figure of inverter, company name, inverter's power rating, etc. The second interface will last for 3 seconds. See Fig6.3.6 for reference.

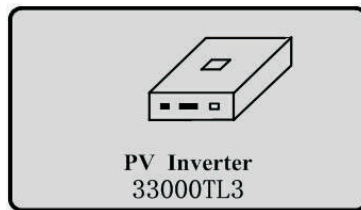

Fig 6.3.6 The second power on interface

After 3 seconds, it will switch to the third interface. See Fig6.3.7 for reference.

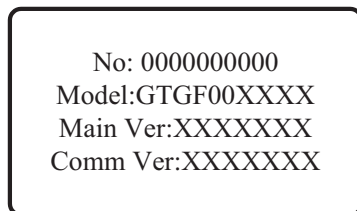

Fig6.3.7 The third power on interface

Here is explanation of items on Fig6.3.7:

- No.: Serial number of this inverter.
- Model: model name of this inverter.
- Main Ver: firmware version of control board.
- Comm Ver: firmware version of communication board.

After displaying information of the third interface for 3 seconds, the background light will turn off.

LCD Display when backlight off

After the power on information is displayed automatically and the backlight turns off, the LCD display will switch to the following Interface 1. There are 4 interfaces, which can be displayed in turn by single knock.

Interface 1: Running state. See Fig 6.3.8 as reference. The first line displays inverter's state description, for example, in faulty state it will display ERROR and followed with faulty codes, which is convenient to compare with error code list in manual. The second line displays inverter's states name; and the third line displays energy generated today, and the forth line displays the total energy generated since installation.

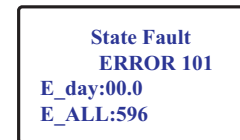

Fig6.3.8 Interface 1: Running state

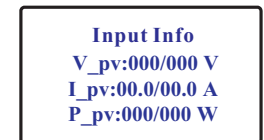

Fig6.3.9 Interface 2: Input information

Interface 2: Input information. See Fig6.3.9 for reference.

This interface displays parameters of PV input, including input voltage, current, and power of each MPP tracker.

- V-pv: Input voltage of MPPT1 and MPPT2
- I-pv: Input current of MPPT1 and MPPT2
- P-pv: Input power of MPPT1 and MPPT2

Interface 3: Output information. See Fig6.3.10 for reference.

This interface displays output information of inverter, including output voltage of each phase, output current of each phase, and output power of each phase.

- V: Output voltage of each phase
- I: Output current of each phase
- P: Output power of each phase

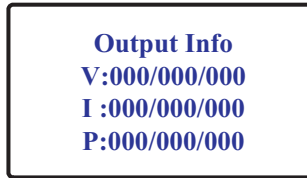

Fig6.3.10 Interface 3: Output information

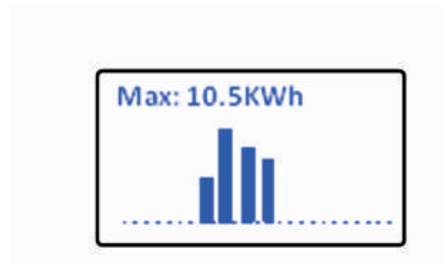

Fig6.3.11 Interface 4: The daily energy yield curve

Interface 4: The daily energy yield curve. See Fig6.3.11 for reference.

This interface shows the generated power of every hour this day.

- Max: maximum energy yield of one hour
- Power curve: The daily energy yield curve

6.3.2.3 Connecting messages

When inverter started to connect to grid, the following message will appear on LCD screen. See Fig6.3.12 for reference.

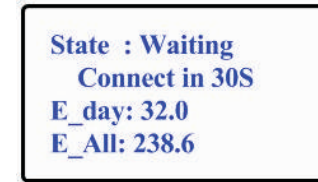

Fig6.3.12 Connect to grid interface

6.3.2.4 LCD Lock and unlock

LCD display will be locked while there is no any operation in two minutes. You need knock four times to unlock LCD. See Fig6.3.13 for reference.

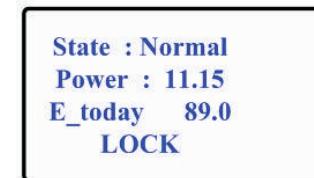

Fig6.3.13 Lock LCD display

6.3.3 Operate by knock

Knock type and definition

The inverter can support four kinds of knock: single knock, double knock, thrice knock, Knock four times. Each kind of knock has different function. Refer to specified definition in Table 6.1.

Table 6.1 Knock definition list

Knock type	Definition
Single knock	Down
Double knock	Enter
Thrice knock	Esc
Knock four times	Unlock LCD

Light backlight and single knock to check running information

Before light the backlight, the four types of knock functions are the same, which is just lighting the backlight. Note that the background lighting will automatically turn off if there is no knock detected in 10 seconds.

During cloudy days or in the area of low light, it's inconvenient for users to check inverter running information such as state, input data, output data, energy generated. In this case user can light the backlight and check those data by single knock, a single knock will switch LCD screen to a following interface. The interface display on LCD screen will circle as follow: Fir6.3.8 -> Fig6.3.9 -> Fig 6.3.10 -> Fig6.3.11-> Fig6.3.12, and then again Fig6.3.8.

6.3.4 Data checking and parameters setting

First level menu

It is a little bit different to enter the first level menu, note that using thrice knock to enter first level menu instead of double knock. Fig 6.3.14 is the interface of first level menu.



Fig 6.3.14 First level menu

In current interface, a single knock will switch the index to next item, double knock will enter the corresponding second level menu.

Second level menu

In first level menu, double knock will lead to next level menu.

The followings are second level menu interfaces for each first level menu items, shown in Fig 6.3.15.

In second level menu, a single knock will switch the index to next item; a double knock will enter the corresponding third level menu. And a thrice knock will back to first level menu.

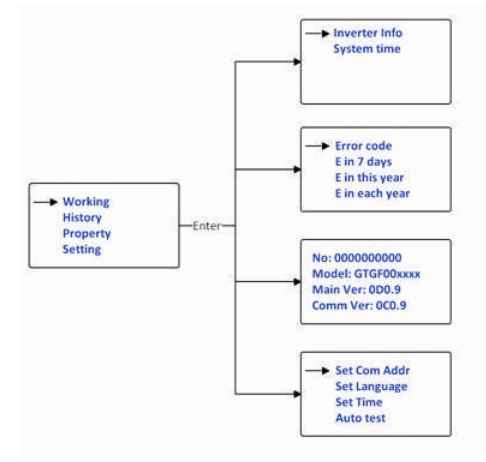

Fig 6.3.15 Second level menu for each first level menu items

Third level menu and explanation

Working information

The followings are third level menu interfaces for each second level menu items of working information, shown in

The followings are third level menu interfaces for each second level menu items of working information, shown in Fig6.3.16

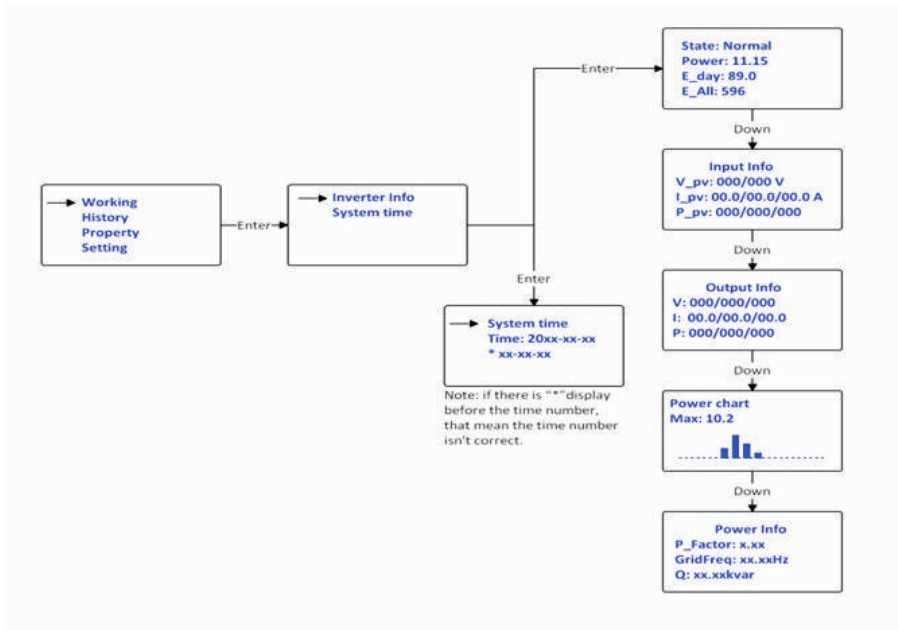

Fig 6.3.16 Third level menu interface of working information

Explanations of each item in third level menu interface of working information:

State information:

Second level menu	Third level items	Item explanation
Inverter info	State: Normal	Inverter running state
	Power: xxx.xx	AC gross output power
	E_day	Energy produced today
	E_all	Energy produced since installation
	Input info	Inverter input parameters
	V_pv: xxx/xxx	PV input voltage for each MPP tracker
	I_pv: xx.x/xx.x	PV input current for each MPP tracker
	P_pv: xxx/xxx	PV input power for each MPP tracker
	Output info	Inverter output parameters
	V: xxx.xxx.xxx	AC output voltage for each phase
	I: xx.x/xx.x/xx.x	AC output current for each phase
P: xxx/xxx/xxx	AC output power for each phase	

Second level menu	Third level items	Item explanation
	Power chart	Histogram of generation power
	Maxrve	Maximum output power of inverter
	Power info	Generation power information of inverter
	P_Factor	Power factor
	Q	Reactive power
	GridFreq	Utility grid frequency

Historical information

Fig 6.3.17 is the third level menu interfaces for each second level menu item of historical information.

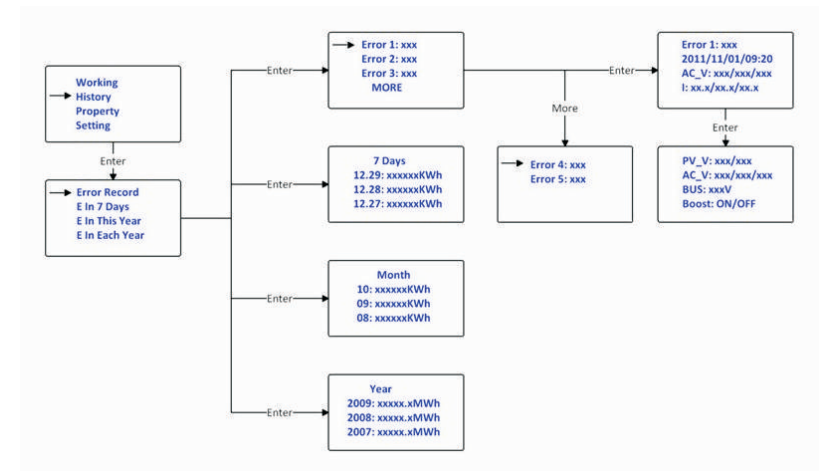

Fig 6.3.17 Third level menu interface of historical information

Explanation of each item in third level menu interface of working information:

State information:

Table 6.3 Historical information sub-items explanation

Second level menu	Third level items	Item explanation
Error Record	Error1: xxx	Five latest error records
	Error2: xxx	
	Error3: xxx	
	Error4: xxx	
	Error5: xxx	
	More	More error record
E in 7 Days	7 Days	Title indicates this is latest 7 days running data
	MM:DD: xxxx.x Kwh	Format is Month:Date, xxxx.x is energy generated in that day.
E in Each Month	Month	Title indicates this is every month's running data in this year.
	MM: xxxx.x Kwh	xxxx.x is energy generated in that month.
E in Each Year	Year	Title indicates this is latest 10 years running data.
	20XX: xxxx.x Mwh	xxxx.x is energy generated in the corresponding year.

Property information

Fig 6.3.18 is the second level menu interfaces of property

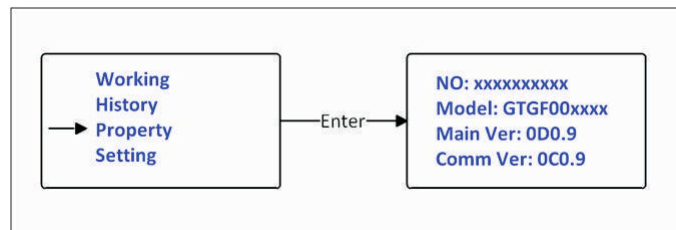

Fig 6.3.18 Property information

Explanation of each item in third level menu interface of working information:

State information:

First level menu	Second level items	Item explanation
Property	No.:xxxxxxxx	Serial number of this inverter.
	Model: xxxxxxxxxx	Model name of this inverter.
	Main Ver:xxxxxx	Firmware version of Control Board
	Comm Ver: xxxxxx	Firmware version of Communication Board

Parameters set

Fig 6.3.19 is the setting information in second level menu.

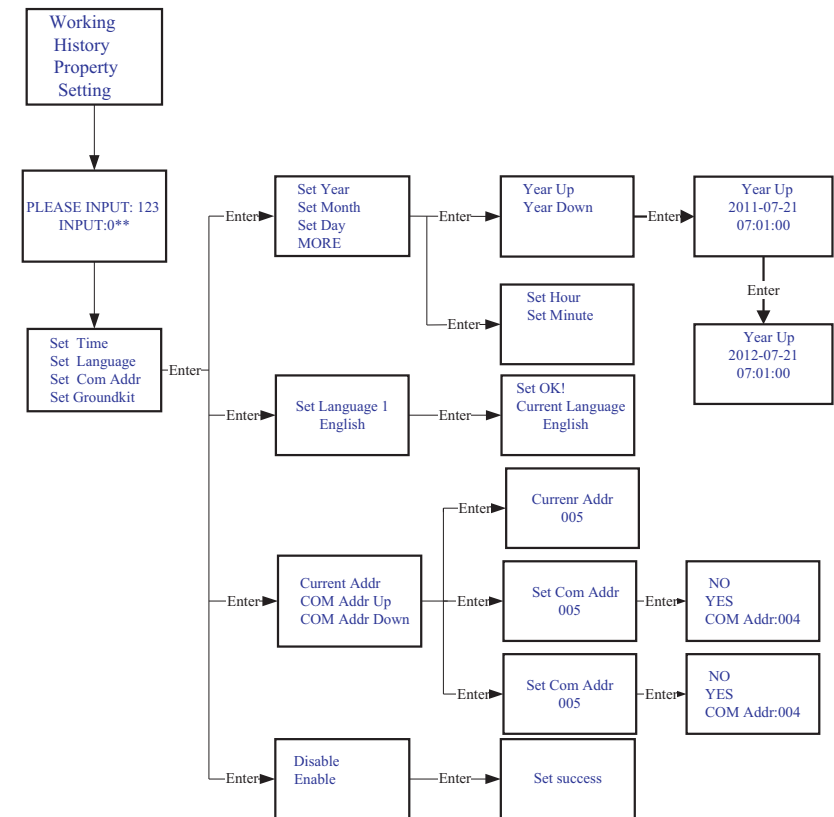

Fig 6.3.19 setting second level menu and its sub-menus

Setting inverter's COM address

When communicating with monitoring software or device, the software or device may regard inverter's COM address as communication address (Also may use inverter's serial number as communication address).The COM address could be assigned. The second level menu "Set COM Addr" of setting is to set inverter's COM address.

Setting steps:

Input password->Setting->Set COM addr->Set Manual, "Current Addr" is the current address of inverter."COM Addr Up"add address. "COM Addr Up" decrease address. Single knock to change value of fixed address, double knock enter next manual. Choose "YES"to save changes, and LCD screen will display "Set Addr OK! Current Addr XXX", see Fig 6.3.19 for reference.

Setting language

To change inverter's displaying language, please select Setting->Set language, then LCD screen will display current language type, single knock to change current language, double knock will save changes and displays "Set Language OK! Current Language English" see Fig 6.3.19 for reference.

Please note in order to prevent disoperation, system language won't be change in second level menu "Set language", but it will be only if user saves save the choice by double knock and LCD displays "Set OK!"

The inverter provides five languages: Italian, English, German, Spanish, and French. The number on Set language interface is sequence number of these five languages, the sequence number and its corresponding language are shown in Table6.5.

Table6.5 sequence number of languages

Language	Sequence Number
Italian	0
English	1
German	2
Spanish	3
French	4

Setting inverter time

Inverter provides a system clock; user must set the system time after installation, as the historical statistic data for a period were based on the clock. User can set the following time parameters: year, month, day, hour, minute. Refer to Fig 6.3.19.

Set year: Setting->Set time->Set year->Year up or Year down->knock to change year. Thrice knock to exit and save changes.

Set month: Setting->Set time->Set month->Month up or Month down->knock to change month. Thrice knock to exit and save changes.

Set date: Setting->Set time->Set date->Date up or Date down->knock to change date. Thrice knock to exit and save changes.





Set hour: Setting->Set time->Set hour->Hour up or Hour down->knock to change Hour. Thrice knock to exit and save changes.

Set minute: Setting->Set time->Set minute->minute up or minute down->knock to change minute. Thrice knock to exit and save changes.

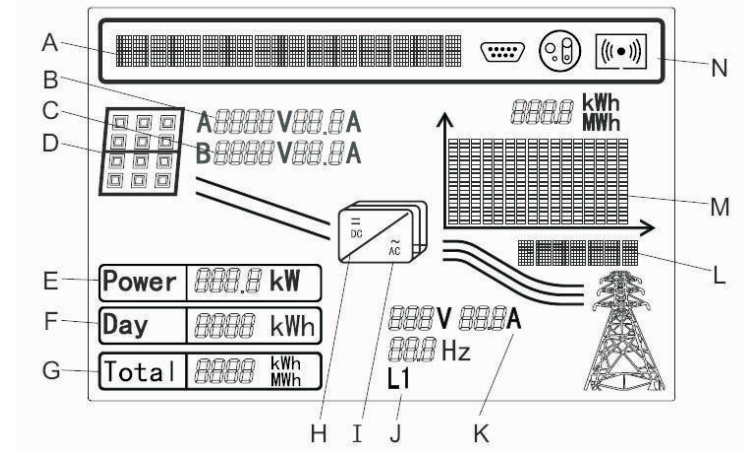
5.8. Special connecting

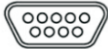
6.4.1 Graphic display



Position	Detail	
A	Text line for displaying an event	
B	Input voltage and current of MPPTA	
C	Input voltage and current of MPPTB	
D	PV array A and B, Light when the array voltage is above the start voltage(250Vdc)	
E	Current power	
F	Daily energy	
G	Total energy generated since the inverter was installed	
H	Light when the array voltage is above the start voltage(250Vdc)	
I	Lighted when "H" is lighted and feed-in	
J	Output phase of the line conductor, switch every 5 seconds	
K	Output voltage /current /frequency of the line conductor	
L	Graphical display of the inverter energy/power	
M		
		RS 232 communication
		RS 485 communication
		External wireless communication
		Internal wireless communication

6.4.2 Graph

The inverter energy and/or power is shown as a graph on the display. The lower right-hand bar of the graph represents the current unit of time: Day/h, Week/day, Month/M, Year/Y. The top bar of the graph represents the maximum value of the graph values. The daily graph is displayed by default. You can trip the enclosure lid three times to switch the current unit of time and the generation information.

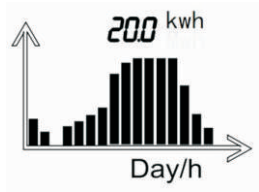
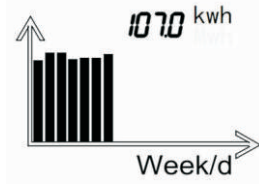
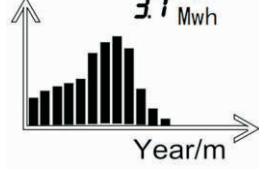
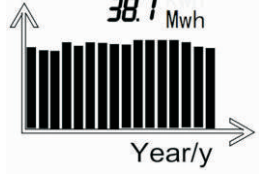
	The graph shows recent 16 hours the energy yield of and the maximum energy yield of the 16 values.
	The graph shows recent 7 days the energy yield of and the maximum energy yield of the 7 values.
	The graph shows recent 12 months the energy yield of and the maximum energy yield of the 12 values.
	The graph shows recent 16 years the energy yield of and the maximum energy yield of the 16 values.

6.4.3 Text line

The Text line is used for displaying an event. Include the information of setting language, models, communication address, and time. The "Power Rate" and "Power Factor" are take turn to display by default. You need input "123" before enter into the setting interface.

You can operate the inputting "123":

1) Single knock the enclosure lid until the text line switch to the text as follow:



2) Double knock, the text will show "input123 : 000".



3) Double knock the enclosure lid ready to input password. Single knock to change value of first, double knock enter into next position.



4) Knock the enclosure lid three times to enter into setting interface.



5) Knock the enclosure lid four times to exit setting interface.

You can operate the settings as follow:

a) Setting language

1) Knock the enclosure lid once every time until the text line switch to the text as follow:



2) Knock the enclosure lid twice and the text will show the language.



3) You can choose the language by tripping the enclosure once; the language includes English, Deutsh, Espanol, Francais, Italiano.

4) Then you can trip the enclosure three times to confirm the language you have chosen. And the text line change as follow:



The language is set!

b) Setting Com Address



For the communicating, the inverter needs a communication address. In multi system, the addresses of inverters must be different from one to another.

1) Single knock until the text line switch to the text as follow:



2) Double knock the enclosure lid and the lower number text "1" will flash: 001.

3) If you want to change it, single knock to change it from 0 to 9.



4) If you want to set the address more larger, double knock the enclosure lid to let the higher number text "002" flashing. And single knock the enclosure lid to change it from 0 to 9. So as the highest number text. In the general condition, the maximum number of the address is within 32.



5) Then you can knock the enclosure three times to confirm the address you have set. And the text line change as follow:



The Com Address is set!

c) Switching the RS232 and the External wireless communication



Information

The default type of communication is Rs232.

1) Trip the enclosure lid once every time until the text line switch to the text as follow:



2) Double knock the enclosure lid and switching to external wireless communication.



3) Then knock the enclosure three times to confirm it. And the text line change as follow :



The External wireless communication is set!

d) Setting date and time

1) Single knock the enclosure lid until the text line switch to the text as follow (the time maybe different depends on the inverter):



2) Double knock the enclosure lid and the text will switch to the year "2012", and the two lower numbers "2012" will flash, you can change it by single knock.



3) Double knock the enclosure lid and switching to the month "01", and it will flash. Then you can change it by single knock.



4) So as to setting the day and the time.



5) Then you need knock the enclosure three times to confirm it. And the text line change as follow:



The date and the time are set!

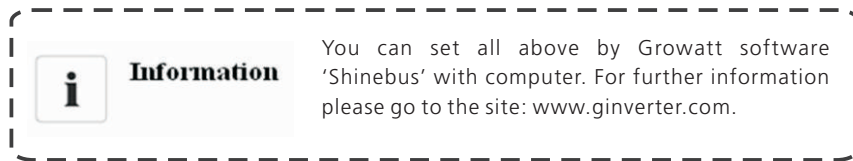

6.4.4 Power display

The power and energy of the inverter are displayed in three fields: Power, Day and Total. The display is updated every five seconds.

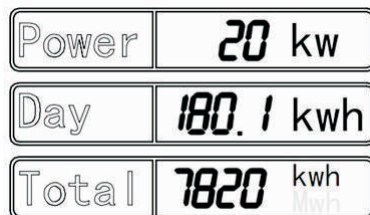

Power

The power is that the inverter is currently feeding into the electricity grid.

Day

The energy fed into the electricity grid on this particular day. This equals the energy generated from the inverter's start-up in the morning to the current time.

Total

The total energy is that the inverter has fed into the electricity grid during its entire operating time.

Measurement accuracy

The display values may deviate from the actual values and must not be used for billing purposes. The inverter's measurement values are required for the operational control and to control the current to be fed into the electricity grid. The inverter does not have a calibrated meter.

6.5 Double MPPT of the Growatt TL3

The Growatt TL3 includes dual input section to process two strings with independent MPPT, high speed and precise MPPT algorithm for real-time power tracking and energy harvesting, as well as transformerless operation for high performance, the max conversion efficiency is up to 98.2%. The wide input voltage range makes the inverter suitable to low power operation as well as the high power operation.

As the weather influence and the location of two MPPT PV arrays different, the power of the MPPT A inputs is different from the power inputs of the MPPT B at the same time, the Growatt TL3 works at a non-symmetrical input state. But the MPPT algorithm of the inverter makes it tracking the maximum power point of every MPPT channel to improve the energy utilization of the PV arrays.

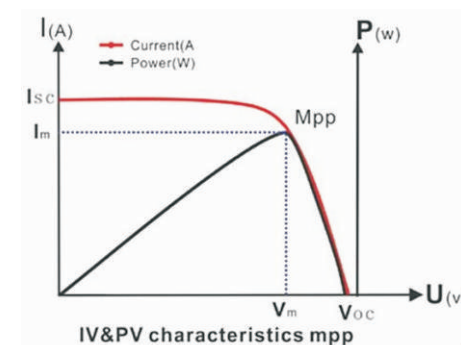

6.6 Communication

6.6.1 Using Shinebus to set the information of the inverter or update firmware

About the software of Shinebus and the usage of it please download from the web: www.growatt.com



The connecting diagram as follow:

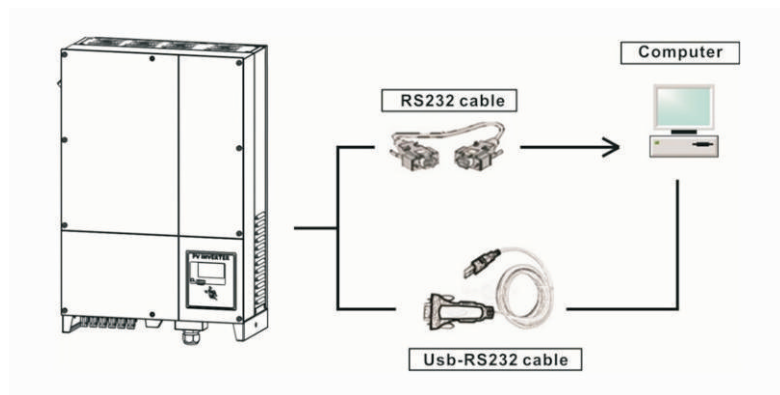

Active power control with a ripple control signal receiver

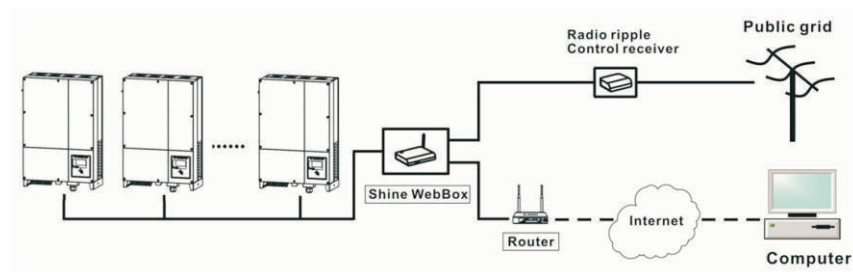

6.6.2 Monitor the inverters

The inverter provides RS485 interface and RS232 interface to communicate with remote PC or logger. User can monitor the inverter state via the following types of communication systems.

You can update firmware via RS232 or Rs485

Plan A:

- Through RS485 interface-Data logger-PC.

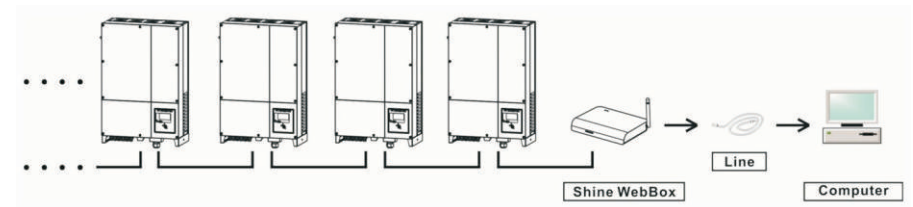

- Through RS485 interface-RS485-232 /RS232 converter-PC.

i Information If you plan to update firmware via RS485 on your plant, please disconnect the monitor device or stop the monitor software first.

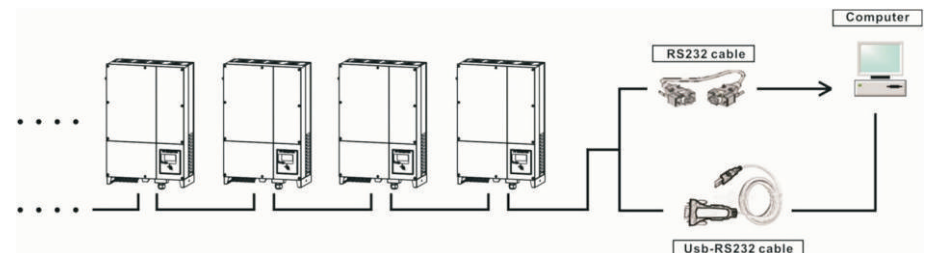

- Through RS232 interface- wireless module-Data logger-PC.

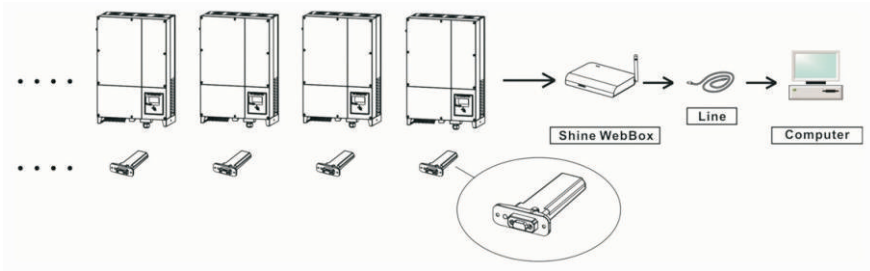

- Through RS232 interface- wireless module-Data logger-Internet.

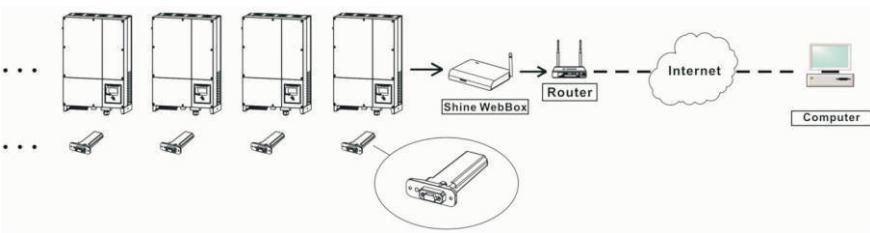

Plan B

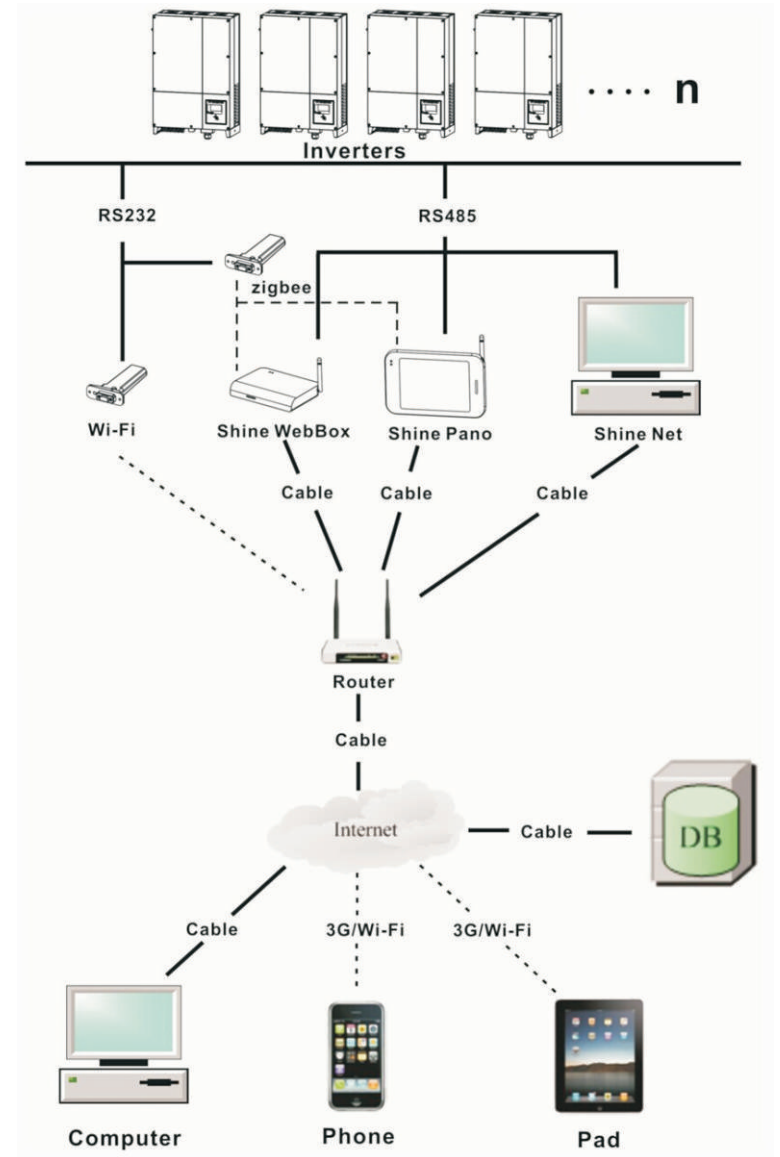

i Information

When three phase inverter and single-phase inverter shared a RS485 communication line, the total length of which does not exceed 1km.

6.6.3 RS485 cable connection

1. Please loosen four screws, take down the RS485 waterproof cover from inverter. If you don't choose RS485 as communication method, keep it on the inverter.

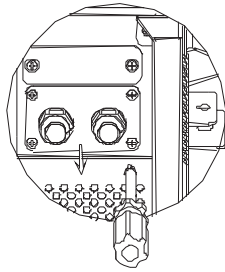

2. Slightly loosen the swivel nut, remove the filler-plug from the M16 cable gland.

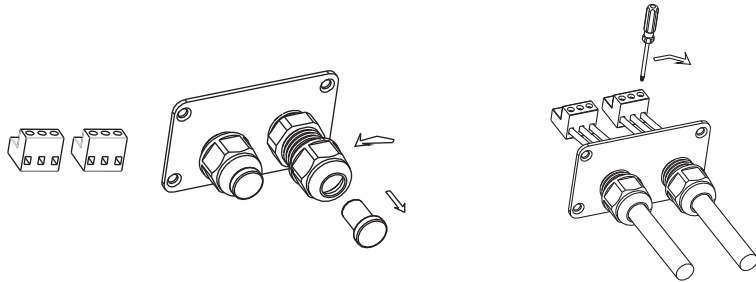

3. Make the cable through the hole of cable gland and put the cable into the RS485 terminals, fix all cables with screwdriver ('1'to'1', '3'to'3', '2' to the shielding layer or no connection.). The type of cable is recommended as below:STP ,FTP ,ASTP.

i Information

Pull cables outwards to confirm whether they are installed firmly.

4. Plug in two terminals. Cover the fix board.

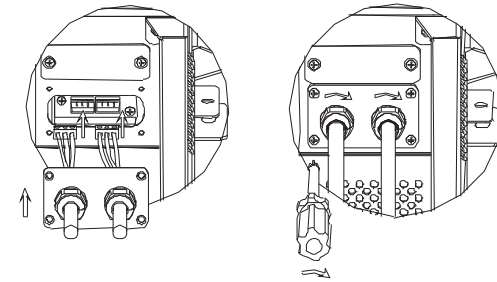

i Information

Tighten 4 pcs screws first, then tighten cable gland.

5. Tighten 4 pcs screws and cable gland.

Note:

1) As to the connection between inverters, please refer to the following figure.

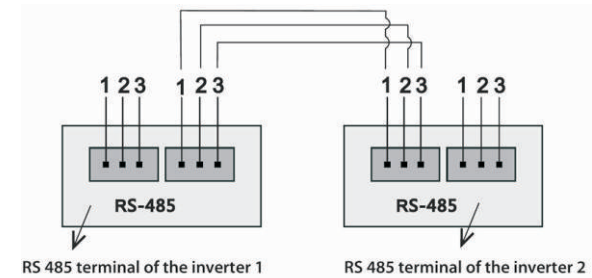

2) As to the connection between inverter and ShineWebBox (ShinePano), please refer to the following figure.

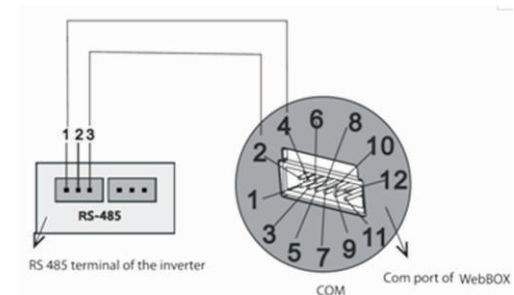

7 Start-Up and shut down the inverter

7.1 Start-Up the inverter

1. Turn on the AC grid breaker;
2. Turn on the DC switch of the inverter, and the inverter will start automatically when the input voltage is higher than 300V.

7.2 Shut down the Inverter

1. Turn off the AC grid breaker;
2. Turn off the DC switch of the inverter.
3. Check the inverter operating state.
4. Until the display of LCD goes out, the inverter is shut down.

Maintenance and Cleaning 8

Once the output power is derating because of too high warming, some tips can help you solve such problems:

- The heatsink or cooling fans are clogged.
- Cooling fans failed.
- Ventilation of installation location is poor. Choose appropriate installation location before mounting.

Cleaning Fans and Heatsink

Maintain fans and heatsink every half a year to reduce the power derating caused by excessive heat.



WARNING Don't use pressurized air to clean the fan. This can damage the fan.

Cleaning or exchanging fan and cleaning heatsink procedure

1. Please disconnect the DC and AC connection.
 - Turn off the DC switch.
 - Disconnect the DC terminal. (You need one tool to disconnect the male and female terminals)
 - Disconnect the Ac breaker.
2. Remove AC line from the inverter output terminal.

Remove the inverter from mounting bracket, and place inverter horizontally on clean and dry place.

3. Screw off the screws to open the cover with suitable tool, then fans will be seen, as figures below:

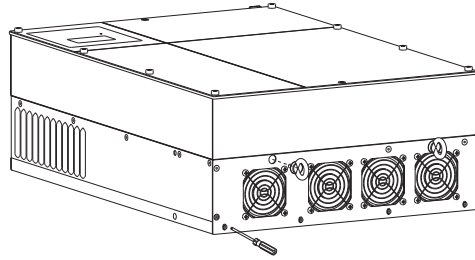

Fig 8.1

The number of fan is 1、 2、 3、 4 from right to left, the internal fan number is 5.

4. Pull out the white connectors with some tinny tools.

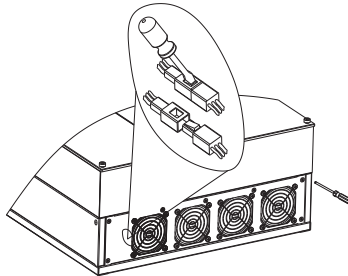

Fig 8.2

5. Clean the heatsink with pressurized air.

6. Take away all fans from the cover and clean them thoroughly or exchange the defective fan.

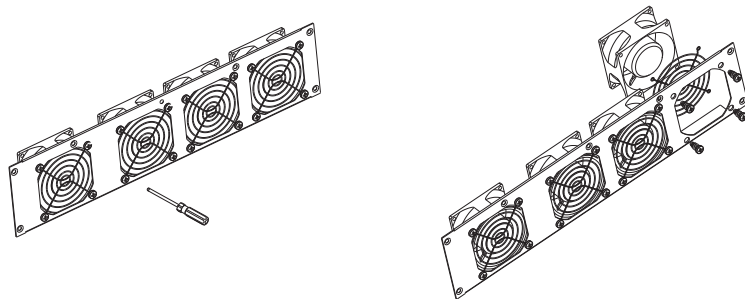

Fig 8.3

7. When finishing cleaning or exchanging, put back the fans in reverse order.

Our quality control program assures that every inverter is manufactured to accurate specifications and is thoroughly tested before leaving our factory. If you have difficulty in the operation of your inverter, please read through the following information to correct the problem.

9.1 Error Messages displayed on LCD

An error message will be displayed on the LCD screen when a fault occurs. The faults consist of system fault and inverter fault.

You may be advised to contact Growatt in some situation, please provide the following information.

Information concerning the inverter:

- Serial number
- Model number
- Error message on LCD
- Short description of the problem
- Grid voltage
- DC input voltage
- Can you reproduce the failure? If yes, how?
- Has this problem occurred in the past?
- What was the ambient condition when the problem occurred?

Information concerning the PV panels:

- Manufacturer name and model number of the PV panel
- Output power of the panel
- Voc of the panel
- Vmp of the panel
- Imp of the panel
- Number of panels in each string

If it is necessary to replace the unit, please ship it in the original box.

9.1.1 System fault

System fault (system faults are mainly caused by system instead of inverter, please check the items as instructed below before replacing inverter).

Error message	Description	Suggestion
AC V Outrange	Utility grid voltage is out of permissible range.	<ol style="list-style-type: none"> 1. Check grid voltage. 2. Check AC wiring, especially the ground wire. 3. If the error message still exists despite the grid voltage being within the tolerable range, contact Growatt.
AC F Outrange	Utility grid frequency out of permissible range.	<ol style="list-style-type: none"> 1. Check grid voltage. 2. Check AC wiring, especially the ground wire. 3. If the error message still exists despite the grid voltage being within the tolerable range, contact Growatt.
PV Isolation Low	Insulation problem.	<ol style="list-style-type: none"> 1. Check if panel enclosure ground properly. 2. Check if inverter ground properly. 3. Check if the DC breaker gets wet. 4. Check the impedance of PV (+) & PV (-) between ground (must be more than 1 MΩ). If the error message is displayed despite the above checking passed, contact Growatt.
Residual I High	Leakage current too high.	<ol style="list-style-type: none"> 1. Restart invert 2. If error message still exists, contact Growatt.
Output High DCI	Output current DC offset too high.	<ol style="list-style-type: none"> 1. Restart inverter. 2. If error message still exists, contact Growatt.

Error message	Description	Suggestion
PV Voltage High	The DC input voltage is exceeding the maximum tolerable value.	<ol style="list-style-type: none"> 1. Disconnect the DC wire immediately. 2. Check the voltage of each PV string with multimeter. 3. If the voltage of PV string is lower than 980V, contact Growatt.
Auto Test Failed	Auto test didn't pass.	Restart inverter, repeat Auto Test, if problem still exist, contact Growatt.
Over Temperature	NTC OPEN or the temperature of heatsink is too high.	If the ambient temperature of inverter is lower than 60°C, restart invert, if error message still exists, contact Growatt.

9.1.2 Inverter warning

Warning code	Meanings	Suggestion
Warning100	Problem with fan 1, fan 2, fan 3, fan 4 or fan 5.	<ol style="list-style-type: none"> 1. Check whether there is anything above fans, clear them. 2. Turn off dc switch, rotate fan blade with screwdriver, then restart inverter. 3. If Warning still exist, contact Growatt.
Warning103	Fail to read EEPROM.	Restart the inverter. If the warning still exist, please contact Growatt customer service to replace the COM board.
Warning104	DSP and COM firmw are version unmatch.	<ol style="list-style-type: none"> 1. Read DSP and COM firmware version from LCD or from RS485, RS232; 2. Check if the firmware is correct; 3. Update the right version firmware.
Warning105	Fail to write EEPROM.	Restart the inverter. If the warning still exist, please contact Growatt customer service to replace the COM board.

9.1.3 Inverter fault

Error code	Meanings	Suggestion
Error: 101	Communication board has not received data from control board for 10 seconds. Electromagnetic Interference cause communication problem.	1. Restart inverter by cutting off DC supply, and Error message will disappear. 2. If the error 101 is often displayed, the environment Electromagnetic Interference is too strong, contact Growatt.
Error: 103	EEPROM fault.	Restart inverter, if problem still exist, contact Growatt.
Error: 111	Problem with PE or Neutral Line	1. Check PE and Neutral line. 2. Restart invert. 3. If error message still exists, contact Growatt.
Error: 117	Relay fault.	Restart inverter, if problem still exist, contact Growatt.
Error: 119	GFCI fault.	Restart inverter, if problem still exist, contact Growatt.
Error: 121	Control board has not received data from Communication board for 5S.	Restart inverter, if problem still exist, contact Growatt.

10.1 Dismantling the Inverter

1. Disconnect the inverter as described in section 7.
2. Remove all connection cables from the inverter.



CAUTION

Danger of burn injuries due to hot enclosure parts!

Wait 20 minutes before disassembling until the housing has cooled down.

3. Screw off all projecting cable glands.
4. Lift the inverter off the bracket and unscrew the bracket screws.

10.2 Packing the Inverter

If possible, always pack the inverter in its original carton and secure it with tension belts. If it is no longer available, you can also use an equivalent carton. The box must be capable of being closed completely and made to support both the weight and the size of the inverter.

10.3 Disposing of the Inverter



Do not dispose of faulty inverters or accessories together with household waste. Please accordance with the disposal regulations for electronic waste which apply at the installation site at that time. Ensure that the old unit and, where applicable, any accessories are disposed of in a proper manner.

11 Specification

11.1 Specification of Growatt TL3

Datasheet	Growatt 30000TL3	Growatt 33000TL3	Growatt 40000TL3
Input Data			
Max. DC power	34500W	36300W	44000W
Max DC voltage	1000V	1000V	1000V
Start Voltage	250V	250V	250V
PV voltage range	180V - 1000V	180V - 1000V	180V - 1000V
Nominal voltage	600V	600V	700V
Full load MPP voltage range	460V - 800V	460V - 800V	550V - 800V
Number of MPP trackers/ strings per MPP tracker	2/3	2/3	2/4
Max. input current	35A / 35A	38A / 38A	38A / 38A
Max. input current per string	12A	12A	12A
Output (AC)			
Rated AC output power	30KW	33KW	40KW
Max. AC apparent power	30KVA	33KVA	40KVA
Max. output current	45.5A	50A	50A
AC nominal voltage	230V/400V,3W+N+PE	230V/400V,3W+N+PE	277V/480V,3W+PE
AC grid frequency	50/60Hz	50/60Hz	50/60Hz
Displacement power factor configurable	0.9 leading - 0.9 lagging	0.9 leading - 0.9 lagging	0.9 leading - 0.9 lagging
THDi @Full load & THDv<1%	<3%	<3%	<3%
Efficiency			
Max. efficiency	98.2%	98.2%	98.2%
Euro - eta	97.6%	97.8%	97.8%
MPPT efficiency	99.5%	99.5%	99.5%
Protection Devices			
DC reverse polarity protection	yes	yes	yes
DC switch for each MPPT	yes	yes	yes
Output AC overcurrent protection	yes	yes	yes
AC over voltage protection	Type III	Type III	Type III
Ground fault monitoring	yes	yes	no
Integrated all-pole sensitive leakage current monitoring unit	yes	yes	yes

Growatt 30000TL3 Growatt 33000TL3 Growatt 40000TL3

General Data	Growatt 30000TL3	Growatt 33000TL3	Growatt 40000TL3
Dimensions (W / H / D)	551/740/276 mm	551/740/276 mm	551/740/276 mm
Weight	61.6kg	61.6kg	61.6kg
Operating temperature range	-25 °C ... +60 °C (with derating above45°C)	-25 °C ... +60 °C (with derating above45°C)	-25 °C ... +60 °C (with derating above45°C)
Noise emission (typical)	≤ 55 dB(A)	≤ 55 dB(A)	≤ 55 dB(A)
Self-Consumption (night)	<0.5W	<0.5W	<0.5W
Topology	Transformerless	Transformerless	Transformerless
Cooling concept	Smart cooling	Smart cooling	Smart cooling
Environmental Protection	IP 65	IP 65	IP 65
Rating	2000m without derating	2000m without derating	2000m without derating
Altitude	2000m without derating	2000m without derating	2000m without derating
Relative Humidity	0~100%	0~100%	0~100%
Features			
DC connection	H4/MC4(opt)	H4/MC4(opt)	H4/MC4(opt)
AC connection	Screw terminal	Screw terminal	Screw terminal
Display	LCD	LCD	LCD
Interfaces: RS232/R485/Ethernet/RF/WiFi	yes / yes / opt / opt / opt	yes / yes / opt / opt / opt	yes / yes / opt / opt / opt
Warranty:5 years / 10 years	yes / opt	yes / opt	yes / opt

11.2 DC connector info

H4 Specification:

Contact size	2.5mm2/14AWG	4mm2/12 AWG	6mm2/10 AWG	10mm2/8AWG
Rated current(at 90 °C)	32A	40A	44A	65A
Rated system voltage	600V DC(UL) 1000V DC(TUV)			
Contact resistance	0.25mΩ TYP			
Degree of protection (mated)	Ip68			
Socket contact material	Copper. Tin plated			
Insulation material	Thermoplastic, UL94 V-0			
Ambient temperature range	-40 °C to +90 °C			
Strip length	7.0mm(9/32)			
Cable jacket diameter	4.5 to 7.8mm(3/16: to 5/16")			

11.3 Torque Values

Enclosure lid screws	1.3Nm(10.8 1bf.in)
Shell and RS232 screws	0.7Nm(6.2 1bf.in)
AC terminal	1.8Nm(16.0 1bf.in)
M6 socket head cap screws for securing the enclosure at the bracket	2Nm(18 1bf.in)
Additional ground screws	2Nm(18 1bf.in)
Fans screws	1Nm(9.0 1bf.in)

11.4 Spare Parts and Accessories

In the following table you will find the optional accessories for your product. If required, you can order these from SHENZHEN GROWATT NEW ENERGY TECHNOLOGY CO., LTD or your dealer.

Name	Description	Growatt order number
Fans	Internal fan of Growatt TL3	025.0006900
	Outside fan of Growatt TL3	025.0007000
		025.0007100
		025.0007200
		025.0007300
ShineLAN	Communication interface	MR00.0003100
Wi-Fi	Communication interface	MR00.0001402
Shine WebBox	Communication data logger	MR00.0001700
Shine Vision receiver	Communication data logger receiver	MR00.0000201
Shine Vision emitter	Communication data logger emitter	MR00.0000601

Growatt TL3 is designed to use worldwide, hence the inverters meet different safety standards of variety countries and regions.

Model	Certificates
Growatt 30000-40000 TL3	EN61000-6-2,EN61000-6-3,EN61000-3-2, EN61000-3-3,EN61000-3-11,EN61000-3-12, IEC62109-1,IEC62109-2,CE,VDE0126-1-1,N4105*

*Pending

13 Contact

If you have technical problems concerning our products, contact your installer or Growatt. During inquiring, please provide below information:

- 1.Inverter type
- 2.Modules information
- 3.Communication method
- 4.Serial number of Inverters
- 5.Error code of Inverters
- 6.Display of inverter

Shenzhen Growatt New Energy Technology CO.,LTD
1st East & 3rd Floor, Jiayu Industrial Zone, Xibianling, Shangwu Village,
Shiyan, Baoan District, Shenzhen,P.R.China

Serviceline

T: +86 755 2747 1900

F: +86 755 2747 1460

E: service@ginverter.com